

Series **1500** ■

product guide

features

- 127 ft (38.70 m)
Five-Section
Boom
- 36 USt (32.66 t)
Rating
- Easy Glide Wear
Pads



contents

Features	2
Mounting Configurations	3
Specifications	4
Capacities	5
Accessories	9
Dimensions Specifications	12

features

Why Buy a National Crane Series 1500?

2



*Product may be shown with optional equipment.

- **36 USt (32.66 t) Rating** – The 1500 provides a 36 USt (32.66t) capacity at a 6 ft (1.82 m) radius, a 9% increase over the Series 1400.
- **127 ft (38.71 m) Five-section Boom** – The long boom allows the operator to perform more lifts without the use of a jib, reducing setup time and improving efficiency.
- **Overload Protection** – All National Crane boom trucks are equipped with overload protection:
 - Load Moment Indicator (LMI) standard on all Series 1500 machines.
 - LMI display and CPU are weatherproof.
 - LCD display is visible in full or low light.
 - All crane load lifting values are displayed simultaneously.
- **Stronger Torsion Box** – The stronger standard torsion box improves rigidity, reduces truck frame flex and reduces the need for counterweight.
- **Speedy-reeve Boom Tip and Sheave Blocks** – These standard features simplify rigging changes by decreasing the time needed to change line reeving.
- **Pre-painted Components** – Painting crane components before assembly reduces the possibility of rust, improves serviceability and enhances the appearance of the machine.
- **Easy Glide Boom Wear Pads** – Reduce the conditions that cause boom chatter and vibration. The net result is smoother crane operation.
- **Deluxe Operator's Cab** – Rigid galvanized steel structure, well insulated, with ample safety glass for operator visibility and comfort. Multi-position seat with arm rest controls, ventilation fans, diesel heater, wipers. Optional air-conditioning is available.
- **Outrigger** – Outrigger span of 24.7 ft (7.53 m) when fully extended; 17.5 ft (5.33 m) at mid-span.
 - Ground-level outrigger controls on both sides.
 - In-cab outrigger controls for all functions.
 - Front bumper stabilizer for stable base over front.
- **Improved Serviceability** –
 - Boom sections are supported by one hydraulic extend cylinder, minimizing maintenance.
 - Bearings on the boom extend and retract cables can be greased through access holes in the boom side plates.
 - Pre-paint reduces rust.
- **Electronic versions of manuals available through Manitowoc Crane Care.**
- **New State-of-the-art Control Valve** – Provides smoother operation. The new load-sensing, pressure-compensated design greatly enhances function meterability, eliminates parts, reduces repair costs and improves the machine's serviceability.
- **National Crane Is the Market Leader** – National Crane is number one in the production of commercial truck-mounted boom trucks, with more than 35,000 units sold. National Crane has many programs and people directly and indirectly involved to provide our customers with reliable products.
- **National Crane has the boom truck industry's leading test program.** Every structural part of the crane is cycle tested, some up to 60,000 cycles at full capacity. In addition to cycle testing, each model is subjected to state-of-the-art strain gauge testing that measures metal deformation as small as one one-millionth of an inch. The net result is that weak areas are caught in test, not on job sites where costly downtime occurs.
- Parts are available for all National Crane machines for the life of the crane.
- National Crane has a formalized quality program and is ISO 9001 approved.

- 36 USt (32.66 t) maximum capacity
- 166 ft (50.60 m) maximum vertical reach*
- 135 ft (41.15 m) maximum vertical hydraulic reach*
- Load Moment Indicator system (LMI)
- Proportional boom extension
- High performance planetary winch
- Vickers PVH 131 pressure compensated, load sensing, axial piston, variable volume pump direct mounts to PTO

* Maximum vertical reach is ground-level to boom tip height at maximum extension and angle with outriggers/stabilizers fully extended.

1500

mounting configurations

3

The configurations are based on the Series 1500 with an 85% stability factor. The complete unit must be installed in accordance with factory requirements and a test performed to determine actual stability and counterweight requirements since individual truck chassis vary.

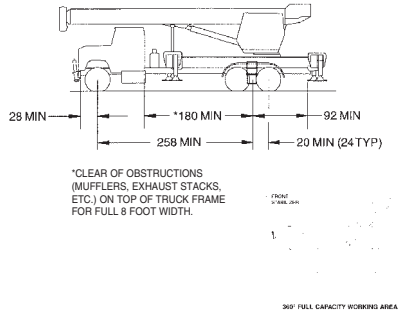

Configuration 1 – 1500

Working area.....	360°
Gross Axle Weight Rating Front.....	20,000 lb (9072 kg)*
Gross Axle Weight Rating Rear.....	34,000 lb (15 422 kg)*
Gross Vehicle Weight Rating.....	54,000 lb (24 494 kg)*
Wheelbase.....	258 in (655 cm)
Cab to Axle/trunnion (CA/CT).....	180 in (457 cm)
After Frame (AF).....	92 in (2.44 m) minimum
Frame Section Modulus (SM), front axle to end of afterframe, w/110,000 PSI (758 MPa).....	30 in ³ (492 cm ³)
Stability Weight, Front.....	9,700 lb (4410 kg) minimum**
Stability Weight, Rear.....	8,500 lb (3865 kg) minimum**
Estimated Average Final Weight.....	51,880 lb (23 587 kg)***

The diagram shows the 360° working area achieved with the front stabilizer (standard on the Series 1500). The front stabilizer is required when extending the boom and lifting loads over the front of the truck. A minimum of 10-in³ (104 cm³) section modulus at 110,000 psi (758 MPa) is required from the rear of the front spring hanger forward to the front stabilizer. Integral front frame extension requested.

*Required to mount basic crane with 30 ft (9.45 m) jib option. Additional options or heavier base chassis weights will require additional axles or a GVWR in excess of 54,000 lb (24 494 kg); in some states, special permits for overload are required.

**Estimated axle scale weights prior to installation of crane, stabilizers and subbase for 85% stability.

***Includes basic crane without jib, 100 gal (379 L) fuel tank and two workers in cab.

Note: Chassis will require extended front frame rails for SFO addition.

MINIMUM TRUCK REQUIREMENTS

Many factors must be considered in the selection of proper truck for a 1500 series crane. Items which must be considered are:

- 1. Axle Rating.** Axle ratings are determined by the axles, tires, rims, springs, brakes, steering and frame strength of the truck. If any one of these components is below the required rating, the gross axle rating is reduced to its weakest component value.
- 2. Wheelbase (WB), Cab-to-Trunnion (CT) and Bare Chassis Weight.** The wheelbase, CT and chassis weights shown are required so the basic 1500 can be legally driven in most states and meet stability requirements. The dimensions given assume the sub-base is installed properly behind the truck cab. If exhaust stacks, transmission protrusions, etc., do not allow a close installation to the cab, the WB and CT dimensions must be increased. Refer to the Mounting Configuration pages for additional information.
- 3. Truck Frame.** Try to select a truck frame that will minimize or eliminate frame reinforcement or extension of the after frame (AF). Many frames are available that have the necessary

after frame (AF) section modulus (S.M.) and resistance to bending moment (RBM) so that reinforcing is not required. The front hydraulic jack is used for a 360° working range around the truck. The frame under the cab through the front suspension must have the minimum S.M. and RBM because reinforcing through the front suspension is often difficult because of engine, radiator mounts and steering mechanics. See "Truck Requirements" and "Frame Strength" information above for the necessary section modulus and resistance to bending moment values.

- 4. Additional Equipment.** In addition to the axle ratings, wheelbase, cab-to-axle requirements and frame, it is recommended that the truck is equipped with electronic engine control, increased cooling and a transmission with a PTO opening available with an extra heavy duty PTO. A conventional cab truck should be used for standard crane mounts.
- 5. Neutral Start Switch.** The chassis must be equipped with a switch that prevents operation of the engine starter when the transmission is in gear.

Notes:

- Gross Vehicle Weight Rating (GVWR) is dependent on all components of the vehicle (axles, tires, springs, frame, etc.) meeting manufacturers' recommendations; always specify GVWR when purchasing trucks.
- Diesel engines require a variable speed governor and energize-to-run fuel solenoid for smooth crane operation; electronic fuel injection requires EET engine remote throttle.
- All mounting data is based on a National Crane Series 1500 with an 85% stability factor (75% stability factor for New York City).
- The complete unit must be installed in accordance with factory requirements, and a test performed to determine actual stability and counterweight requirements per SAE J765; contact the factory for details.

1500

specifications

Boom and Jib Combinations Data

Available in three basic models: 1579 four-section, 15103 four-section and 15127 five-section.

4

Model 1579 – Equipped with a 31-79 ft (9.45-24.08 m) four-section boom. Maximum tip height is 87 ft (25.52 m).

31 - 79 ft (9.45-24.08 m) four-section boom



Model 15103 – Equipped with a 31-103 ft (9.45-31.40 m) four-section boom. This model can be equipped with a 31 ft (9.45 m) single section side-stowing jib providing a maximum tip height of 142 ft (43.29 m), or a 31-55 ft (9.45-16.76 m) side-stowing folding jib, providing a vertical reach of 166 ft (50.60 m). Contact factory for information on angling jib.

31 - 103 ft (9.45-31.40 m) four-section hydraulic boom



31 - 103 ft (9.45-31.40 m) four-section hydraulic boom **15FJ31** 31 ft (9.45 m) single-section jib



31 - 103 ft (9.45-31.40 m) four-section hydraulic boom **15FJ55M** 31-55 ft (9.45-16.76 m) single-section jib



Model 15127 – Equipped with a 31-127 ft (9.45-38.72 m) five-section hydraulic boom. This model can be equipped with a 31 ft (9.45 m) single-section side-stowing jib. Maximum tip height w/31 ft (9.45 m) jib is 166 ft (50.60 m).

31 - 127 ft (9.45-38.72 m) five-section hydraulic boom



31 - 127 ft (9.45-38.72 m) five-section hydraulic boom **15FJ31** 31 ft (9.45 m) single-section manual jib



Note: maximum tip height is measured with outriggers/stabilizers fully extended.

1500 Winch Data

- All winch pulls and speeds are shown on the fifth layer.
- Winch line pulls would increase on the first, second, third and fourth layers.
- Winch line speed would decrease on the first, second, third and fourth layers.
- Winch line pulls may be limited by the winch capacity or the ANSI 5 to 1 cable safety factor.

Winch	Cable Supplied	Average Breaking Strength	1 Part Line	2 Part Line	3 Part Line	4 Part Line	5 Part Line	6 Part Line	7 Part Line	8 Part Line
			Lift and Speed	Lift and Speed	Lift and Speed	Lift and Speed	Lift and Speed	Lift and Speed	Lift and Speed	Lift and Speed
Standard Planetary Winch Low Speed	5/8 in diameter rotation resistant 18 x 19 IWRC	45,400 lb (20593 kg)	9,000 lb (4082 kg) 205 fpm (62 m/m)	18,000 lb (8165 kg) 103 fpm (31 m/m)	27,000 lb (12247 kg) 68 fpm (21 m/m)	36,000 lb (16329 kg) 51 fpm (16 m/m)	45,000 lb (20412 kg) 41 fpm (12 m/m)	54,000 lb (24494 kg) 34 fpm (10 m/m)	63,000 lb (28577 kg) 29 fpm (8 m/m)	72,000 lb (32659 kg) 26 fpm (7 m/m)
Standard Planetary Winch High Speed	Same as corresponding cable data shown above		4,500 lb (2041 kg) 410 fpm (124 m/m)	9,000 lb (4082 kg) 205 fpm (62 m/m)	13,500 lb (6123 kg) 137 fpm (42 m/m)	18,000 lb (8165 kg) 103 fpm (31 m/m)	22,500 lb (10206 kg) 82 fpm (25 m/m)	27,000 lb (12247 kg) 68 fpm (21 m/m)	31,500 lb (14288 kg) 59 fpm (18 m/m)	36,000 lb (16329 kg) 51 fpm (16 m/m)

Winch
Standard planetary
& Auxiliary planetary

Full Drum Pull
4,500 lb (high speed)
9,000 lb (low speed)

Allowable Cable Pull
9,080 lb

Aux Boom Head	100 lb (45 kg)
5 USt Downhaul Weight	180 lb (82 kg)
15 USt 1 Sheave Block	375 lb (170 kg)
25 USt 2 Sheave Block	640 lb (290 kg)
35 USt 3 Sheave Block	870 lb (395 kg)
36 USt 4 Sheave Block	970 lb (440 kg)

1500

capacities

Load Rating Chart: Series 1579 (24.08 m) Boom/Fullspan Outrigger 24.66 ft (7.51m)

National Crane will send you a chart on request – or you may secure needed load rating information through your nearest National Crane dealer.

5

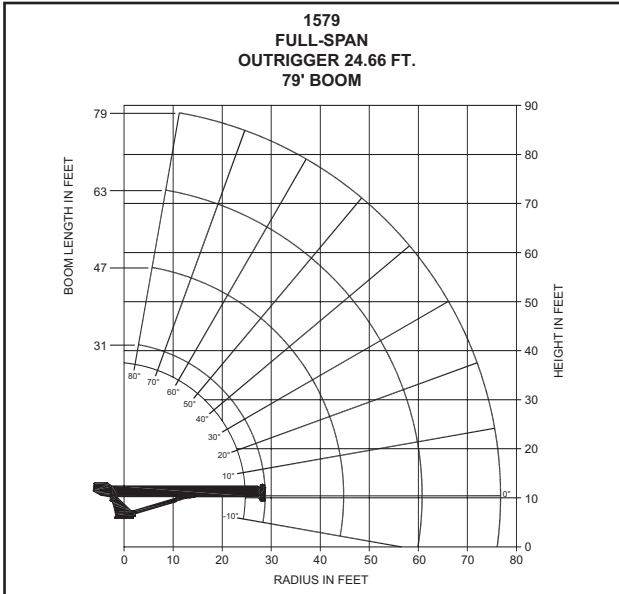

CAUTION:

- Do not operate crane booms, jib extensions, any accessories or loads within 10 ft (3m) of live power lines or other conductors of electricity.
- Jib and boom capacities shown are maximum for each section.
- Do not exceed capacities at reduced radii.
- Load ratings shown on the load rating charts are maximum allowable loads with the outriggers properly extended on a firm, level surface and the crane leveled and mounted on a factory recommended truck.
- Always level the crane with the level indicator located on the crane.
- The operator must reduce load to allow for factors such as wind, ground conditions, operating speeds and their effects on freely suspended loads.
- Overloading this crane may cause structural collapse or instability.
- Weights on any accessories attached to the boom or loadline must be deducted from the load chart capacities.
- Do not exceed jib capabilities at any reduced boom lengths.
- Do not deadhead lineblock against boom tip when extending boom or winching up.
- Keep at least three wraps of loadline on drum at all times.
- Use only specified cable with this machine.

Load Rating Chart: Series 1579 (24.08 m) Boom/Fullspan Outrigger 24.66 ft (7.51m)

**SERIES 1579 (24.08 M)
BOOM/MIDSPAN
OUTRIGGER 24.66 FT
(7.51 M)**

31 TO 79 FOOT BOOM RATED LOADS								
LOAD RADIUS (FEET)	LOADED BOOM ANGLE	31 FT BOOM (lb)	LOADED BOOM ANGLE	47 FT BOOM (lb)	LOADED BOOM ANGLE	63 FT BOOM (lb)	LOADED BOOM ANGLE	79 FT BOOM (lb)
6	75	72,000						
8	71.5	64,000	77.5	45,000				
10	67	55,000	75.5	44,100				
12	62.5	48,000	72.5	39,700	77.5	35,200		
15	56	39,500	69.5	34,300	75	30,800	78.5	26,000
20	43.5	30,800	62.5	27,900	70	25,400	75	22,300
25	27	23,700	55.5	23,800	65	21,400	71	19,100
30			47	18,000	60	18,300	67	16,500
35			38.5	14,100	54.5	14,300	63	14,500
40			26.5	11,400	48.5	11,600	59	11,700
45					41.5	9,600	54.5	9,750
50					34.5	8,100	50	8,200
55					25	6,800	45	6,950
60					9	5,700	39	5,800
65							33	4,900
70							25	4,150
75							13	3,500
	0	17,500	0	9,550	0	5,500	0	3,300

NOTE:

1. All capacities are in pounds, angles in degrees, radius in feet.
2. Loaded boom angles are given as reference only.
3. Shaded areas are structurally limited capacities.

THIS CHART IS ONLY A GUIDE AND SHOULD NOT BE USED TO OPERATE THE CRANE. The individual crane's load chart, operating instructions and other instructional plates must be read and understood prior to operating the crane.

1500

capacities

Load Rating Chart: Series 1579 (24.08 m) Boom/Midspan Outrigger 17.5 ft (5.33 m)

National Crane will send you a chart on request – or you may secure needed load rating information through your nearest National Crane dealer.

6

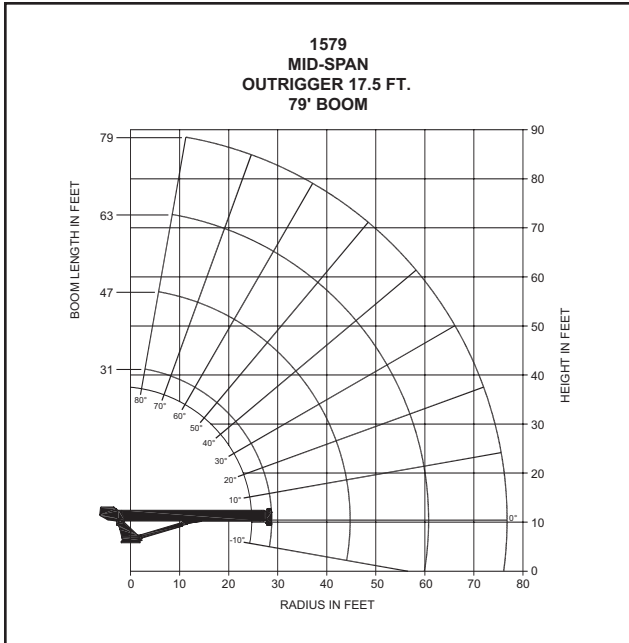

CAUTION:

- Do not operate crane booms, jib extensions, any accessories or loads within 10 ft (3m) of live power lines or other conductors of electricity.
- Jib and boom capacities shown are maximum for each section.
- Do not exceed capacities at reduced radii.
- Load ratings shown on the load rating charts are maximum allowable loads with the outriggers properly extended on a firm, level surface and the crane leveled and mounted on a factory recommended truck.
- Always level the crane with the level indicator located on the crane.
- The operator must reduce load to allow for factors such as wind, ground conditions, operating speeds and their effects on freely suspended loads.
- Overloading this crane may cause structural collapse or instability.
- Weights on any accessories attached to the boom or loadline must be deducted from the load chart capacities.
- Do not exceed jib capabilities at any reduced boom lengths.
- Do not deadhead lineblock against boom tip when extending boom or winching up.
- Keep at least three wraps of loadline on drum at all times.
- Use only specified cable with this machine.

Load Rating Chart: Series 1579 (24.08 m) Boom/Midspan Outrigger 17.5 ft (5.33 m)

**SERIES 1579
(24.08 M) BOOM/MID-
SPAN OUTRIGGER
17.5 FT (5.33 M)**

LOAD RADIUS (FEET)	LOADED BOOM ANGLE	31 ft BOOM (lb)	LOADED BOOM ANGLE	47 ft BOOM (lb)	LOADED BOOM ANGLE	63 ft BOOM (lb)	LOADED BOOM ANGLE	79 ft BOOM (lb)
6	75	72,000						
8	71.5	64,000	77.5	45,000				
10	67	55,000	75.5	44,100				
12	62.5	48,000	72.5	39,700	77.5	35,200		
15	56	39,500	69.5	34,300	75	30,800	78.5	26,000
20	43.5	22,100	62.5	22,700	70	23,200	75	22,300
25	27	14,100	55	14,500	64.5	14,800	71	15,000
30			47	10,200	59.5	10,400	66.5	10,600
35			38	7,500	54	7,700	63	7,850
40			25.5	5,700	48	5,900	58.5	6,000
45					41.5	4,550	54	4,650
50					34	3,550	49.5	3,650
55					24.5	2,750	44	2,850
60					8.5	2,100	38.5	2,200
65							32	1,650
70							24.5	1,200
75							12	800
	0	10,700	0	4,450	0	2,000	0	700

NOTE:

1. All capacities are in pounds, angles in degrees, radius in feet.
2. Loaded boom angles are given as reference only.
3. Shaded areas are structurally limited capacities.

1500

THIS CHART IS ONLY A GUIDE AND SHOULD NOT BE USED TO OPERATE THE CRANE. The individual crane's load chart, operating instructions and other instructional plates must be read and understood prior to operating the crane.

capacities

Load Rating Chart: Series 15103 (16.76 m) Boom with 31-55 ft (9.45-16.76 m) Jib/Fullspan Outrigger 24.66 ft (7.51 m)

National Crane will send you a chart on request – or you may secure needed load rating information through your nearest National Crane dealer.

7

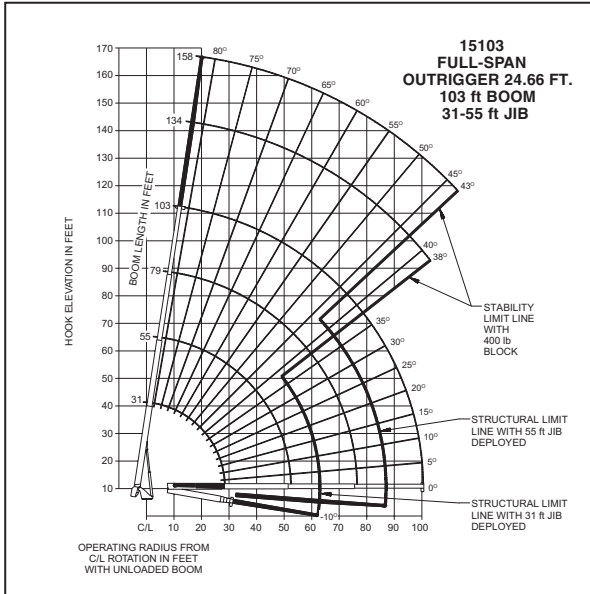

CAUTION:

- Do not operate crane booms, jib extensions, any accessories or loads within 10 ft (3m) of live power lines or other conductors of electricity.
- Jib and boom capacities shown are maximum for each section.
- Do not exceed capacities at reduced radii.
- Load ratings shown on the load rating charts are maximum allowable loads with the outriggers properly extended on a firm, level surface and the crane leveled and mounted on a factory recommended truck.
- Always level the crane with the level indicator located on the crane.
- The operator must reduce load to allow for factors such as wind, ground conditions, operating speeds and their effects on freely suspended loads.
- Overloading this crane may cause structural collapse or instability.
- Weights on any accessories attached to the boom or loadline must be deducted from the load chart capacities.
- Do not exceed jib capabilities at any reduced boom lengths.
- Do not deadhead lineblock against boom tip when extending boom or winching up.
- Keep at least three wraps of loadline on drum at all times.
- Use only specified cable with this machine.

Load Rating Chart: Series 15103 (16.76 m) Boom with 31-55 ft (9.45-16.76 m) Jib/Fullspan Outrigger 24.66 ft (7.51 m)

**SERIES 15103 (24.08 M)
BOOM WITH 31-55 FT
(9.45-16.76 M)
JIB/FULLSPAN OUTRIGGER
24.66 FT (7.51 M)**

31 TO 103 ft BOOM RATED LOADS WITHOUT JIB								31 ft JIB RATED LOADS				
LOAD RADIUS (ft)	LOADED BOOM ANGLE	31 ft BOOM (lb)	LOADED BOOM ANGLE	55 ft BOOM (lb)	LOADED BOOM ANGLE	79 ft BOOM (lb)	LOADED BOOM ANGLE	103 ft BOOM (lb)	RADIUS FULLY EXTENDED	LOADED BOOM ANGLE	RATED LOADS ALL BOOM LENGTHS	
6	75.7	72,000							24	80	8,500	
8	71.6	64,000							37	75	7,500	
10	67.5	55,000	78.6	42,000					48	70	6,400	
12	63.3	48,000	76.4	37,000					59	65	5,100	
15	56.6	39,500	73.1	32,000	79.2	26,000			69	60	3,900	
20	44	30,500	67.5	25,500	75.4	21,000	79.6	15,000	78	55	2,800	
25	27.3	23,000	61.5	21,000	71.6	17,500	76.8	13,500	87	50	1,900	
30			55.2	18,000	67.7	15,200	74	12,000	95	45	1,250	
35			48.3	14,300	63.7	13,400	71.1	11,000	102	40	750	
40			40.5	11,400	59.5	11,600	68.1	10,000				
45			31.1	9,300	54.9	9,500	65.2	9,000				
50			18.7	7,700	50.3	8,000	62	8,000				
55					45.2	6,500	58.6	6,700				
60						39.5	5,300	55	5,500			
65						33	4,400	51.3	4,550			
70						25	3,600	47.4	3,750	29	80	4,000
75						12.7	3,000	43.2	3,050	45	75	3,700
80								38.7	2,500	59	70	3,200
85								33.7	2,050	71	65	2,700
90								27.9	1,600	83	60	2,250
95								20.5	1,250	94	55	1,800
100								7.2	900	104	50	1,300
	0	16,500	0	6,800	0	2,700	0	850	113	45	800	

NOTE:

- Operate with jib by radius when main boom is fully extended. If necessary increase boom angle to maintain loaded radius.
- Operate with jib by boom angle when main boom is not fully extended. Do not exceed rated jib capacities at any reduced boom lengths.
- Capacities do not exceed 85% stability.
- Shaded areas are structurally limited capacities.

RATED LOAD REDUCTIONS WITH JIB		
BOOM LENGTH	31-55 ft JIB STOWED	31-55 ft JIB ERRECTED AT 31 ft LENGTH
31 ft	Reduce load 800 lb	Reduce load 2,300 lb
55 ft	Reduce load 450 lb	Reduce load 2,000 lb
79 ft	Reduce load 350 lb	Reduce load 1,900 lb
103 ft	Reduce load 250 lb	Reduce load 1,800 lb

NOTE:

- All capacities are in pounds, angles in degrees, radius in feet.
- Loaded boom angles are given as reference only.
- Shaded areas are structurally limited capacities.

THIS CHART IS ONLY A GUIDE AND SHOULD NOT BE USED TO OPERATE THE CRANE. The individual crane's load chart, operating instructions and other instructional plates must be read and understood prior to operating the crane.

1500

capacities

Load Rating Chart: Series 15103 (16.76 m) Boom with 31-55 ft (9.45-16.76 m) Jib/Midspan Outrigger 17.5 ft (5.33 m)

National Crane will send you a chart on request – or you may secure needed load rating information through your nearest National Crane dealer.

8

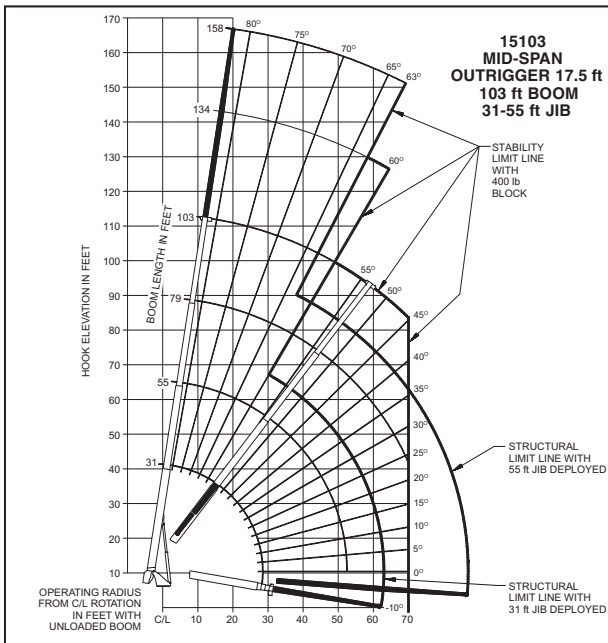

CAUTION:

- Do not operate crane booms, jib extensions, any accessories or loads within 10 ft (3m) of live power lines or other conductors of electricity.
- Jib and boom capacities shown are maximum for each section.
- Do not exceed capacities at reduced radii.
- Load ratings shown on the load rating charts are maximum allowable loads with the outriggers properly extended on a firm, level surface and the crane leveled and mounted on a factory recommended truck.
- Always level the crane with the level indicator located on the crane.
- The operator must reduce load to allow for factors such as wind, ground conditions, operating speeds and their effects on freely suspended loads.
- Overloading this crane may cause structural collapse or instability.
- Weights on any accessories attached to the boom or loadline must be deducted from the load chart capacities.
- Do not exceed jib capacities at any reduced boom lengths.
- Do not deadhead lineblock against boom tip when extending boom or winching up.
- Keep at least three wraps of loadline on drum at all times.
- Use only specified cable with this machine.

Load Rating Chart: Series 15103 (16.76 m) Boom with 31-55 ft (9.45-16.76 m) Jib/Midspan Outrigger 17.5 ft (5.33 m)

**SERIES 15103 (24.08 M)
BOOM WITH 31-55 FT
(9.45-16.76 M) JIB/MID-
SPAN OUTRIGGER
17.5 FT (5.33 M)**

NOTE:

1. Operate with jib by radius when main boom is fully extended. If necessary increase boom angle to maintain loaded radius.
2. Operate with jib by boom angle when main boom is not fully extended. Do not exceed rated jib capacities at any reduced boom lengths.
3. Capacities do not exceed 85% stability.
4. Shaded areas are structurally limited capacities.

31 TO 103 ft BOOM RATED LOADS WITHOUT JIB									31 ft JIB RATED LOADS		
LOAD RADIUS (ft)	LOADED BOOM ANGLE	31 ft BOOM (lb)	LOADED BOOM ANGLE	55 ft BOOM (lb)	LOADED BOOM ANGLE	79 ft BOOM (lb)	LOADED BOOM ANGLE	103 ft BOOM (lb)	RADIUS FULLY EXTENDED	LOADED BOOM ANGLE	RATED LOADS ALL BOOM LENGTHS
6	75.7	72,000							24	80	8,500
8	71.6	64,000							36	75	6,900
10	67.5	55,000	78.6	42,000					46	70	3,750
12	63.3	48,000	76.4	37,000					56	65	2,000
15	56.6	39,500	73.1	32,000	79.2	26,000			66	60	850
20	44	21,300	67.3	22,000	75.4	21,000	79.6	15,000			
25	27.4	13,300	61.1	14,000	71.3	14,100	76.8	13,500			
30			54.7	9,700	67.2	9,800	73.6	9,800			
35			48.2	7,100	63.2	7,200	70.6	7,200			
40			40.5	5,150	58.9	5,350	67.4	5,400			
45			31.3	3,800	54.4	4,000	64.2	4,000			
50			18.1	2,750	49.6	2,950	60.9	3,000			
55					44.5	2,150	57.5	2,150			
60					38.8	1,450	54	1,500			
65					32.3	950	50.4	1,000			
70					24.2	475	46.5	550			
	0	10,100	0	2,300							

55 ft JIB RATED LOADS		
RADIUS FULLY EXTENDED	LOADED BOOM ANGLE	RATED LOADS ALL BOOM LENGTHS
31	80	4,000
46	75	3,700
58	70	2,400
69	65	1,250

RATED LOAD REDUCTIONS WITH JIB		
BOOM LENGTH	31-55 ft JIB STOWED	31-55 ft JIB ERRECTED AT 31 ft LENGTH
31 ft	Reduce load 800 lb	Reduce load 2,300 lb
55 ft	Reduce load 450 lb	Reduce load 2,000 lb
79 ft	Reduce load 350 lb	Reduce load 1,900 lb
103 ft	Reduce load 250 lb	Reduce load 1,800 lb

NOTE:

1. All capacities are in pounds, angles in degrees, radius in feet.
2. Loaded boom angles are given as reference only.
3. Shaded areas are structurally limited capacities.

THIS CHART IS ONLY A GUIDE AND SHOULD NOT BE USED TO OPERATE THE CRANE. The individual crane's load chart, operating instructions and other instructional plates must be read and understood prior to operating the crane.

1500

capacities

Load Rating Chart: Series 15127 (38.71 m) Boom with 31 ft (9.45 m) Jib/Fullspan Outrigger 24.66 ft (7.51 m)

National Crane will send you a chart on request – or you may secure needed load rating information through your nearest National Crane dealer.

9

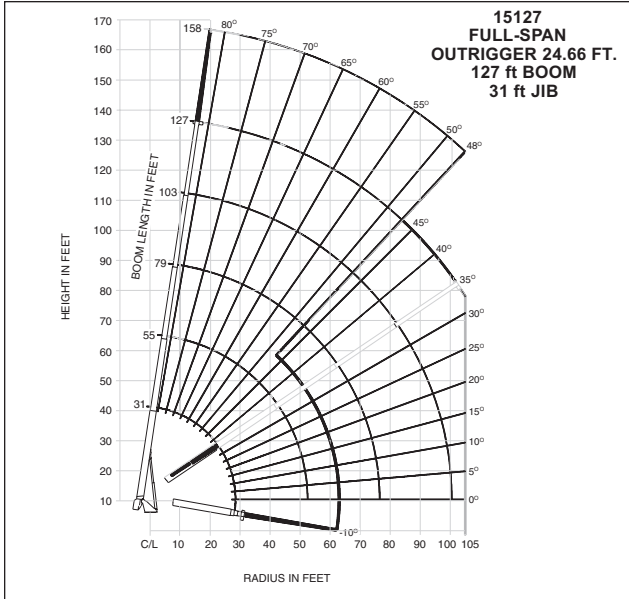

CAUTION:

- Do not operate crane booms, jib extensions, any accessories or loads within 10 ft (3m) of live power lines or other conductors of electricity.
- Jib and boom capacities shown are maximum for each section.
- Do not exceed capacities at reduced radii.
- Load ratings shown on the load rating charts are maximum allowable loads with the outriggers properly extended on a firm, level surface and the crane leveled and mounted on a factory recommended truck.
- Always level the crane with the level indicator located on the crane.
- The operator must reduce load to allow for factors such as wind, ground conditions, operating speeds and their effects on freely suspended loads.
- Overloading this crane may cause structural collapse or instability.
- Weights on any accessories attached to the boom or loadline must be deducted from the load chart capacities.
- Do not exceed jib capabilities at any reduced boom lengths.
- Do not deadhead lineblock against boom tip when extending boom or winching up.
- Keep at least three wraps of loadline on drum at all times.
- Use only specified cable with this machine.

Load Rating Chart: Series 15127 (38.71 m) Boom with 31 ft (9.45 m) Jib/Fullspan Outrigger 24.66 ft (7.51 m)

**SERIES 15127 (38.71 M)
BOOM WITH 31 FT
(9.45 M) JIB/FULL-SPAN
OUTRIGGER 24.66 FT
(7.51 M)**

LOAD RADIUS (ft)	LOADED BOOM ANGLE	31 ft BOOM (lb)	LOADED BOOM ANGLE	55 ft BOOM (lb)	LOADED BOOM ANGLE	79 ft BOOM (lb)	LOADED BOOM ANGLE	103 ft BOOM (lb)	LOADED BOOM ANGLE	127 ft BOOM (lb)	
6	76.4	72,000									
8	72.2	63,000									
10	68	54,000									
12	63.7	47,000	76.8	36,000							
15	57	38,500	73.5	31,000	79.5	25,000					
20	44.3	29,500	67.8	24,600	75.8	20,500	79.6	14,000			
25	27.1	22,000	61.8	20,500	71.9	17,000	77	13,000	79.5	8,700	
30			55.5	17,400	68	14,700	74.2	11,700	77.5	8,200	
35			48.6	14,000	63.9	12,900	71.3	10,600	75.3	7,700	
40			40.7	11,000	59.7	11,300	68.4	9,500	73.1	7,200	
45			31.3	9,000	55.2	9,400	65.4	8,400	70.8	6,700	
50			18.9	7,400	50.6	7,800	62.2	7,600	68.5	6,200	
55					45.4	6,500	58.9	6,600	65.9	5,400	
60					39.6	5,300	55.3	5,500	63.3	4,800	
65					33.1	4,300	51.5	4,500	60.6	4,200	
70					25.1	3,500	47.6	3,700	57.8	3,700	
75						12.7	2,850	43.4	3,050	55	3,100
80								38.8	2,400	51.9	2,550
85								33.8	1,900	48.7	2,050
90								27.9	1,500	45.4	1,600
95								20.5	1,100	41.9	1,200
100								7.3	800	38.1	850
105										34	550
0		15,500	0	6,300	0	2,600	0	750			

NOTE:

1. Operate with jib by radius when main boom is fully extended. If necessary increase boom angle to maintain loaded radius.
2. Operate with jib by boom angle when main boom is not fully extended. Do not exceed rated jib capacities at any reduced boom lengths.
3. Capacities do not exceed 85% stability.
4. Shaded areas are structurally limited capacities.

31 ft JIB RATED LOADS		
RADIUS FULLY EXTENDED	LOADED BOOM ANGLE	RATED LOADS ALL BOOM LENGTHS
29	80	3,800
44	75	3,300
58	70	2,900
72	65	2,500
84	60	2,150
94	55	1,600
104	50	1,000

RATED LOAD REDUCTIONS WITH JIB

BOOM LENGTH	31 ft JIB STOWED		31 ft JIB ERRECTED	
	Reduce load	Reduce load	Reduce load	Reduce load
31ft	500 lb		1,600 lb	
55ft	300 lb		1,400 lb	
79ft	200 lb		1,300 lb	
103ft	150 lb		1,250 lb	
127ft	100 lb		1,200 lb	

NOTE:

1. All capacities are in pounds, angles in degrees, radius in feet.
2. Loaded boom angles are given as reference only.
3. Shaded areas are structurally limited capacities.

THIS CHART IS ONLY A GUIDE AND SHOULD NOT BE USED TO OPERATE THE CRANE. The individual crane's load chart, operating instructions and other instructional plates must be read and understood prior to operating the crane.

capacities

Load Rating Chart: Series 15127 (38.71 m) Boom with 31 ft (9.45 m) Jib/Midspan Outrigger 17.5 ft (5.33 m)

National Crane will send you a chart on request – or you may secure needed load rating information through your nearest National Crane dealer.

10

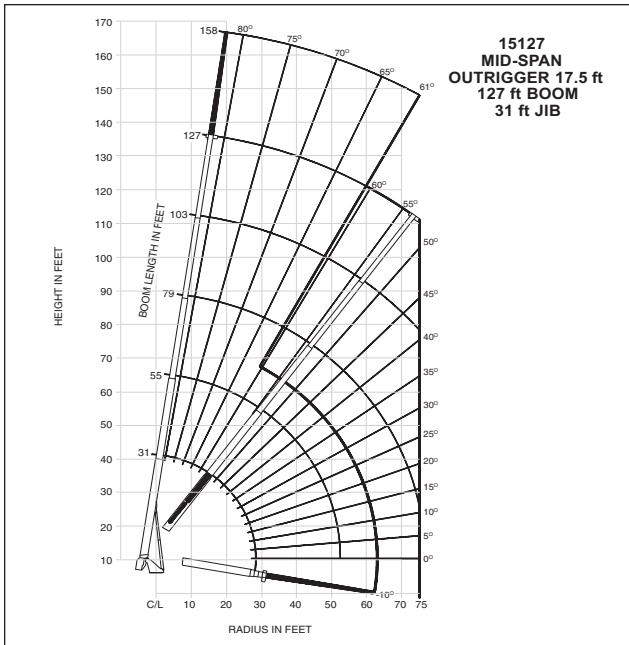

CAUTION:

- Do not operate crane booms, jib extensions, any accessories or loads within 10 ft (3m) of live power lines or other conductors of electricity.
- Jib and boom capacities shown are maximum for each section.
- Do not exceed capacities at reduced radii.
- Load ratings shown on the load rating charts are maximum allowable loads with the outriggers properly extended on a firm, level surface and the crane leveled and mounted on a factory recommended truck.
- Always level the crane with the level indicator located on the crane.
- The operator must reduce load to allow for factors such as wind, ground conditions, operating speeds and their effects on freely suspended loads.
- Overloading this crane may cause structural collapse or instability.
- Weights on any accessories attached to the boom or loadline must be deducted from the load chart capacities.
- Do not exceed jib capacities at any reduced boom lengths.
- Do not deadhead lineblock against boom tip when extending boom or winching up.
- Keep at least three wraps of loadline on drum at all times.
- Use only specified cable with this machine.

Load Rating Chart: Series 15127 (38.71 m) Boom with 31 ft (9.45 m) Jib/Midspan Outrigger 17.5 ft (5.33 m)

**SERIES 15127
(38.71 M) BOOM
WITH 31 FT (9.45 M)
JIB/MID-SPAN
OUTRIGGER
17.5 FT (5.33 M)**

LOAD RADIUS (ft)	LOADED BOOM ANGLE	31 ft BOOM (lb)	LOADED BOOM ANGLE	55 ft BOOM (lb)	LOADED BOOM ANGLE	79 ft BOOM (lb)	LOADED BOOM ANGLE	103 ft BOOM (lb)	LOADED BOOM ANGLE	127 ft BOOM (lb)
6	76.4	72,000								
8	72.2	63,000								
10	68	54,000								
12	63.7	47,000	76.8	36,000						
15	57	38,500	73.5	31,000	79.5	25,000				
20	44.1	22,100	67.7	23,500	75.8	20,500	79.6	14,000		
25	27.4	13,400	61.4	18,400	71.7	15,300	77	13,000	79.5	8,700
30			54.9	10,100	67.4	10,600	74	10,700	77.5	8,200
35			48.4	7,300	63.4	7,700	70.9	7,900	75.3	7,700
40			40.6	5,200	59.1	5,700	67.6	5,900	72.7	6,000
45			31.3	3,800	54.5	4,200	64.3	4,400	70.1	4,600
50			18.2	2,700	49.7	3,100	61	3,300	67.4	3,400
55					44.5	2,200	57.6	2,400	64.7	2,500
60					38.8	1,500	54	1,650	62	1,800
65					32.2	850	50.3	1,050	59.3	1,200
70					24.2	400	46.4	550	56.4	650
0		9,400	0	2,200						

NOTE:

- Operate with jib by radius when main boom is fully extended. If necessary increase boom angle to maintain loaded radius.
- Operate with jib by boom angle when main boom is not fully extended. Do not exceed rated jib capacities at any reduced boom lengths.
- Capacities do not exceed 85% stability.
- Shaded areas are structurally limited capacities.

31 ft JIB RATED LOADS		
RADIUS FULLY EXTENDED	LOADED BOOM ANGLE	RATED LOADS ALL BOOM LENGTHS

RATED LOAD REDUCTIONS WITH JIB		
BOOM LENGTH	31 ft JIB STOWED	31 ft JIB ERECTED
	'	Reduce load 500 lb
'	Reduce load 300 lb	Reduce load 1,400 lb
'	Reduce load 200 lb	Reduce load 1,300 lb
'	Reduce load 150 lb	Reduce load 1,250 lb
'	Reduce load 100 lb	Reduce load 1,200 lb

NOTE:

- All capacities are in pounds, angles in degrees, radius in feet.
- Loaded boom angles are given as reference only.
- Shaded areas are structurally limited capacities.

THIS CHART IS ONLY A GUIDE AND SHOULD NOT BE USED TO OPERATE THE CRANE. The individual crane's load chart, operating instructions and other instructional plates must be read and understood prior to operating the crane.

1500

Radio Remote Controls –

Eliminate the handling and maintenance concerns that accompany cabled remotes. Operate to a range of about 250 ft (76 m), varying with conditions.

- **NB4R** (R4 functions)

One-Person Basket –

Strong but lightweight steel basket with 300 lb (139 kg) capacity, gravity hung with swing lock and full body harness.

- **B1-S**
- **2B1-S** (for dual locking baskets)

Heavy-duty Personnel Basket –

1,200 lb (544 kg) capacity steel basket with safety loops for four passengers. Gravity leveling 72 x 42 in (183 x 107 cm) platform. Fast attachment and secure locking systems.

- **BSA-1**
- **BSA-R1** (provides rotation)

Air Conditioning for Crane Cab –

(Requires larger truck alternator) Provides excellent crane cab cooling to overcome the radiant heat from the sun reflection.

- **A/C**

Auxiliary Winch 9,000 lb Line Pull –

Second winch redundant to the main, planetary winch with boom tip “rooster sheave” to allow reeving of both winch lines.

- **15AW**

Winch Drum Rotation Indicator –

Winch drum rotation indicator on winch control lever or in cab (for use with standard and auxiliary winches).

- **WDRI**
- **WDRI-2**

Hour Meter –

Hour meter in truck cab to record crane operation hours.

- **HRM**

Steel Tool Box Options

Spanish-Language Danger Decals, Control Knobs, and Operators' Manuals

- **SDD**
- **SOM**

dimension specifications

Dimensions Specifications

12

MODEL	RETRACTED LENGTH	EXTENDED LENGTH	CENTER OF GRAVITY	WITH OIL/WT.
15103	31 ft (9.45 m)	103 ft (31.40 m)	85 in (2.16 m)	30,776 lb (13 960 kg)
15127	32 ft (9.45 m)	127 ft (38.72 m)	89 in (2.26 m)	32,201 lb (14 606 kg)

*WEIGHT INCLUDES ALL ITEMS INCLUDING COMPLETE HO OUTRIGGERS, 180 lb (82 kg) DOWNHAUL WEIGHT, RESERVOIR, DECKS, LADDERS, AND SFO. BOOMS FULLY RETRACTED.

ALL DIMENSIONS IN INCHES (MM) UNLESS OTHERWISE SPECIFIED

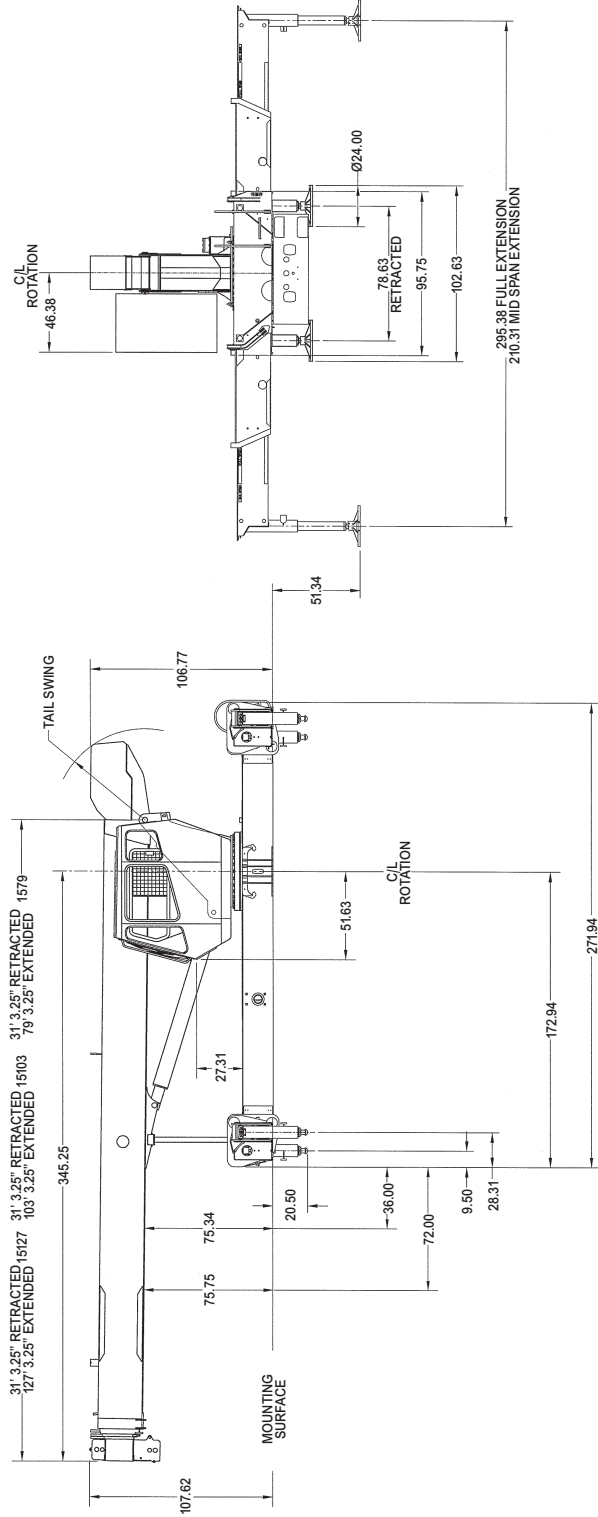
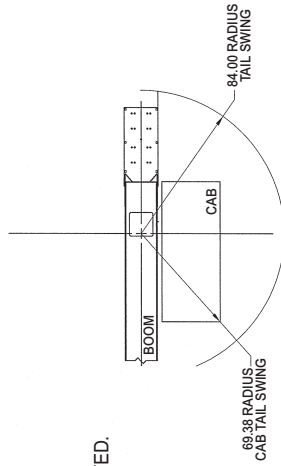

Regional Headquarters

Americas

Manitowoc, Wisconsin, USA

Tel: +1 920 684 6621

Fax: +1 920 683 6278

Shady Grove, Pennsylvania, USA

Tel: +1 717 597 8121

Fax: +1 717 597 4062

Regional Offices

Americas

Brazil

Alphaville

Tel: +55 11 3103 0200

Fax: +55 11 4688 2013

Mexico

Monterrey

Tel: +52 81 8124 0128

Fax: +52 81 8124 0129

Europe, Middle East, Africa

Algeria

Hydra

Tel: +21 3 21 48 1173

Fax: +21 3 21 48 1454

Czech Republic

Netvorice

Tel: +420 317 78 9313

Fax: +420 317 78 9314

France

Baudemont

Tel: +33 385 28 2589

Fax: +33 385 28 0430

Cergy

Tel: +33 130 31 3150

Fax: +33 130 38 6085

Decines

Tel: +33 472 81 5000

Fax: +33 472 81 5010

Germany

Langenfeld

Tel: +49 21 73 8909-0

Fax: +49 21 73 8909 30

Hungary

Budapest

Tel: +36 13 39 8622

Fax: +36 13 39 8622

Italy

Parabiago

Tel: +390 331 49 3311

Fax: +390 331 49 3330

Europe, Middle East, Africa

Ecully, France

Tel: +33 472 18 2020

Fax: +33 472 18 2000

Netherlands

Breda

Tel: +31 76 578 3999

Fax: +31 76 578 3978

Poland

Warsaw

Tel: +48 22 843 3824

Fax: +48 22 843 3471

Portugal

Alfena

Tel: +351 229 69 8840

Fax: +351 229 69 8848

Lisbon

Tel: +351 212 109 340

Fax: +351 212 109 349

Russia

Moscow

Tel: +7 495 641 2359

Fax: +7 495 641 2358

U.A.E.

Dubai

Tel: +971 4 3381 861

Fax: +971 4 3382 343

U. K.

Middlesex

Tel: +44 1 895 43 0053

Fax: +44 1 895 45 9500

Sunderland

Tel: +44 191 522 2000

Fax: +44 191 522 2052

Asia – Pacific

Australia

Melbourne

Tel: +61 3 9 336 1300

Fax: +61 3 9 336 1322

Sydney

Tel: +61 2 9 896 4433

Fax: +61 2 9 896 3122

Asia – Pacific

Shanghai, China

Tel: +86 21 51113579

Fax: +86 21 51113578

Singapore

Tel: +65 6264 1188

Fax: +65 6862 4142

China

Beijing

Tel: +86 10 58674761

Fax: +86 10 58674760

Xi'an

Tel: +86 29 87891465

Fax: +86 29 87884504

Korea

Seoul

Tel: +82 2 3439 0400

Fax: +82 2 3439 0405

Philippines

Makati City

Tel: +63 2 844 9437

Fax: +63 2 844 4712

Factories

Brazil

Alphaville

China

Zhangjiagang

France

Charlieu

La Clayette

Moulins

Germany

Wilhelmshaven

India

Calcutta

Pune

Italy

Niella Tanaro

Portugal

Baltar

Fânzeres

Slovakia

Saris

U.S.A.

Manitowoc

Port Washington

Shady Grove



Constant improvement and engineering progress make it necessary that we reserve the right to make specification, equipment and price changes without notice. Illustrations shown may include optional equipment and accessories, and may not include all standard equipment.